

**S T R I M K O**<sup>TM</sup>

your streamy logic

24 easy 4x4 puzzles

# R U L E S

The object of the puzzle is to fully fill in the given grid with missing numbers observing three simple rules. You have numbers 1 through 3 for a 3 x 3 grid; 1 through 4 for a 4 x 4 grid; 1 through 5 for a 5 x 5 grid; 1 through 6 for a 6 x 6 grid; 1 through 7 for a 7 x 7 grid; and so on.

## Rule #1

Each row must contain different numbers.

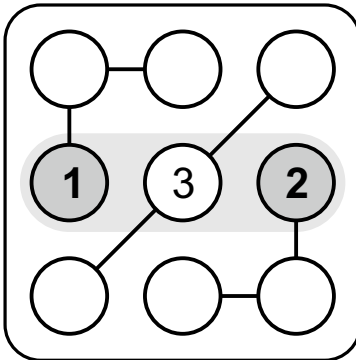

## Rule #2

Each column must contain different numbers.

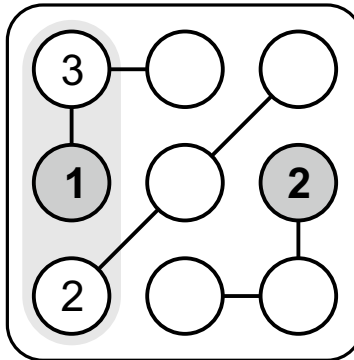

## Rule #3

Each stream must contain different numbers.

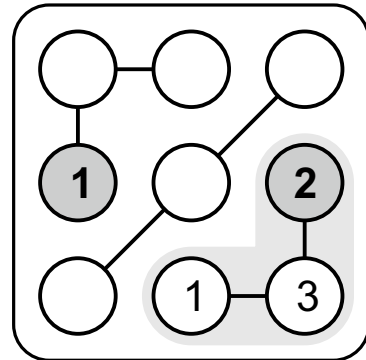

# E X A M P L E

## Start

Let's solve the easiest 3 x 3 Strimko logic puzzle step-by-step.

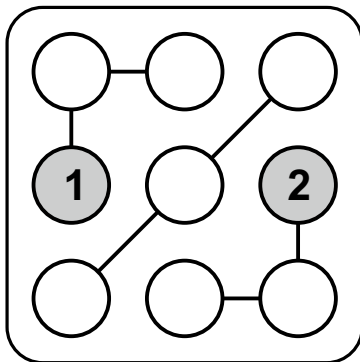

## Step #1

In the second row only one number is missing. Thus we can put in the grid our first number, 3.

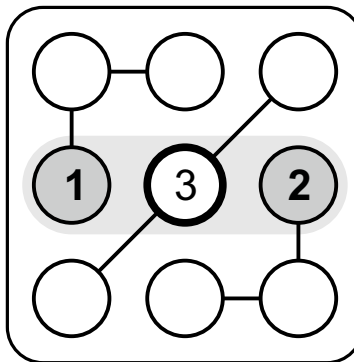

## Step #2

In the diagonal stream we can put in its top right cell only 1, and in its bottom left cell only 2. One stream is fully filled now.

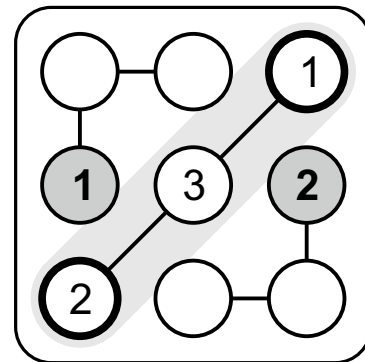

## Step #3

Now we can put two missing 3's; they must go in the middle cells of the two opposite corner-like streams.

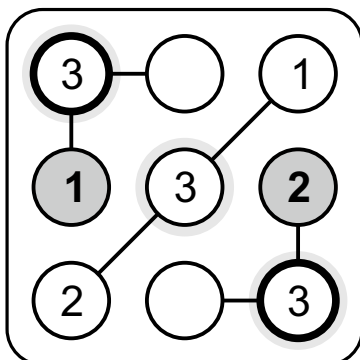

## Step #4

Finally, we have to complete both corner-like streams putting 2 in the top vacant cell, and 1 in the bottom one.

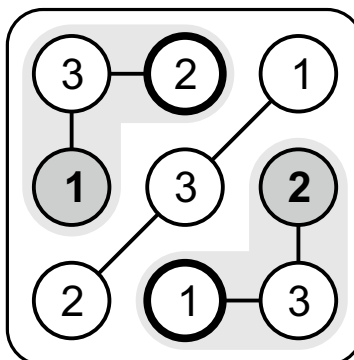

## Finish

Congratulations!  
You have solved your first Strimko logic puzzle.

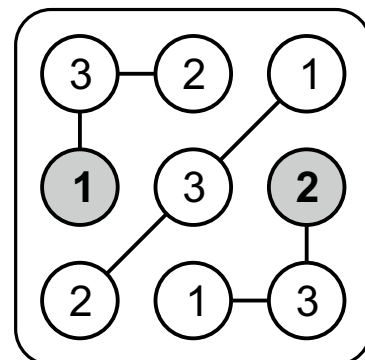

**P U Z Z L E S**

February 2016 | v 1.0

**S T R I M K O**<sup>TM</sup>

© 2009 The Grabarchuk Family. All Rights Reserved. [strimko.com](http://strimko.com)  
Permission is granted for personal use only. This puzzle may not be duplicated for any kind of profit

Puzzle 1

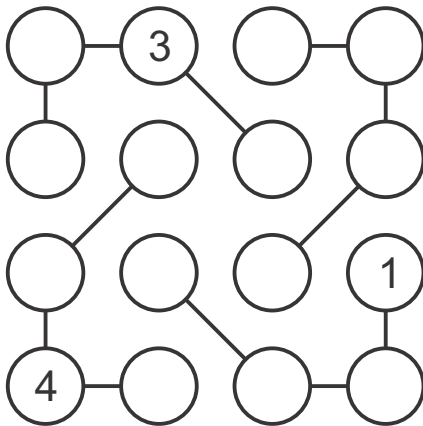

Puzzle 2

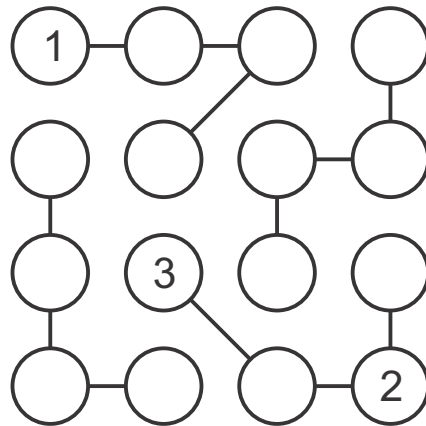

Puzzle 3

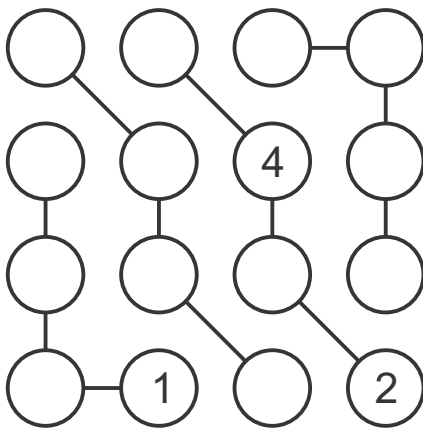

Puzzle 4

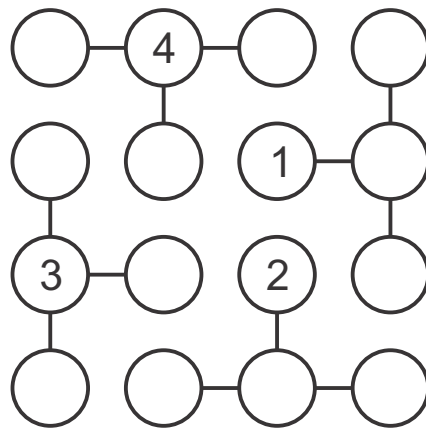

Puzzle 5

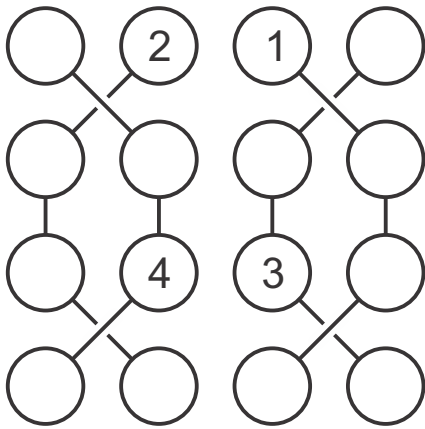

Puzzle 6

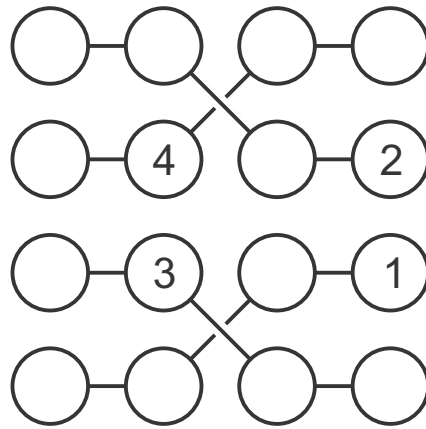

Puzzle 7

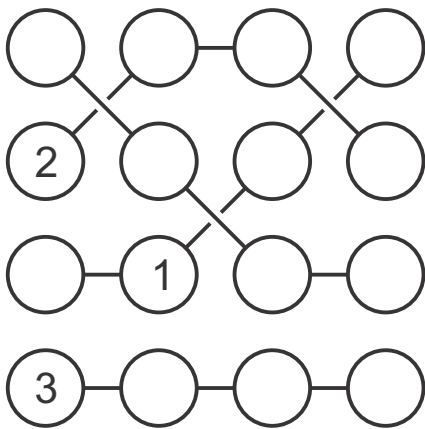

Puzzle 8

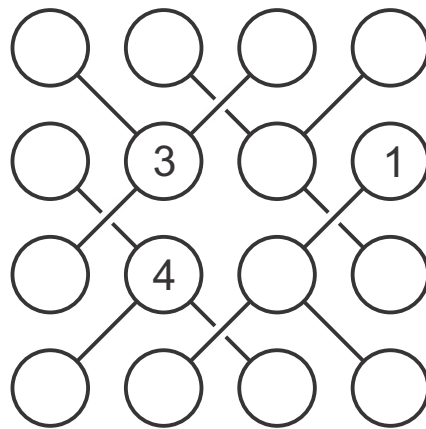

Puzzle 9

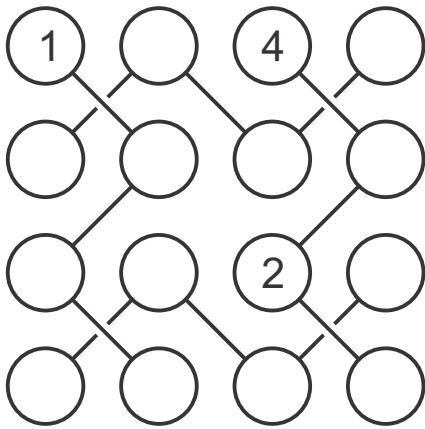

Puzzle 10

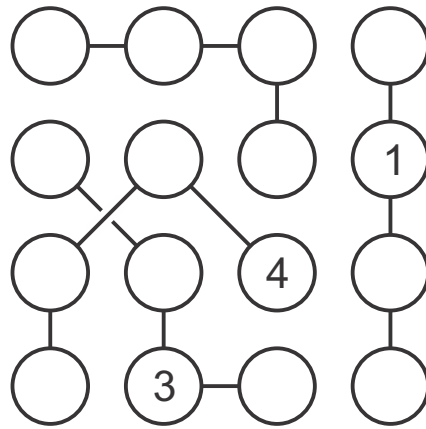

Puzzle 11

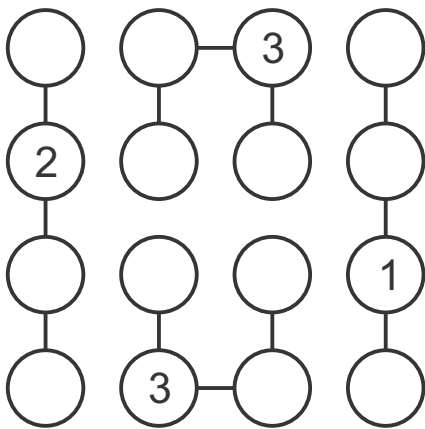

Puzzle 12

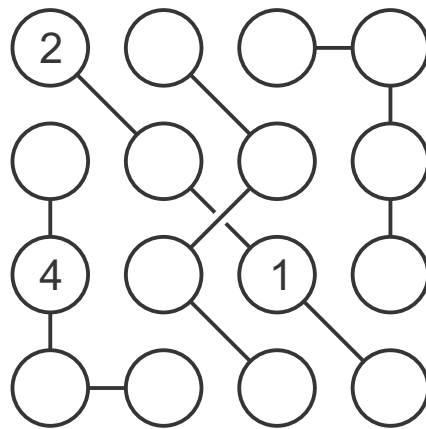

Puzzle 13

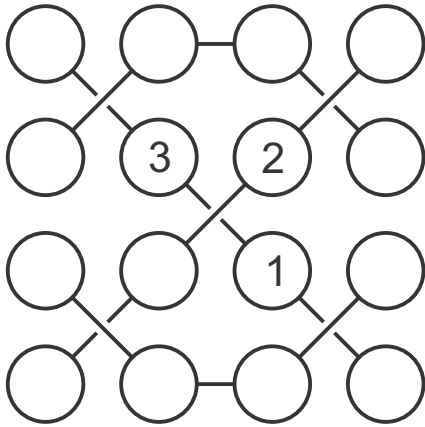

Puzzle 14

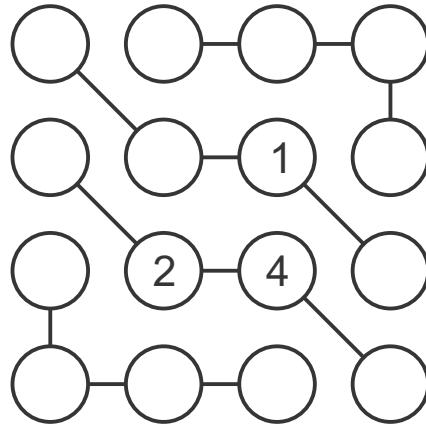

Puzzle 15

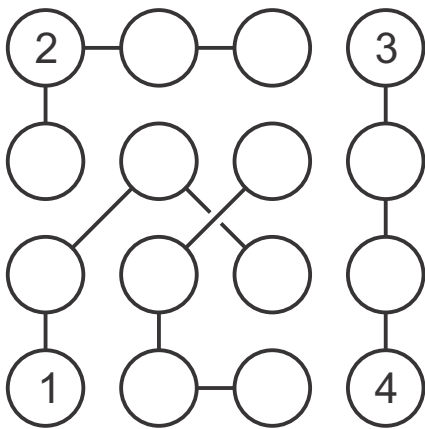

Puzzle 16

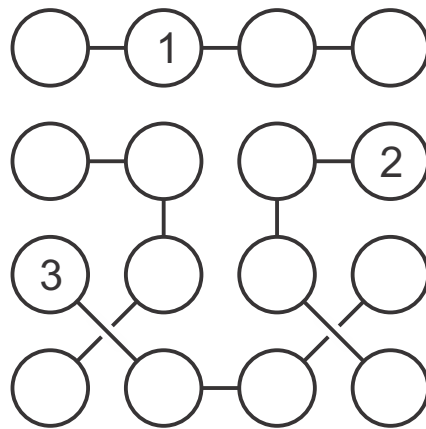



Puzzle 17

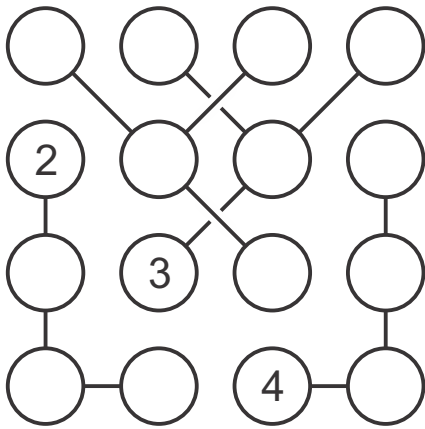

Puzzle 18

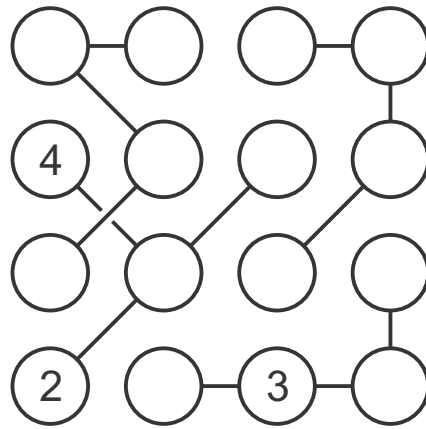

Puzzle 19

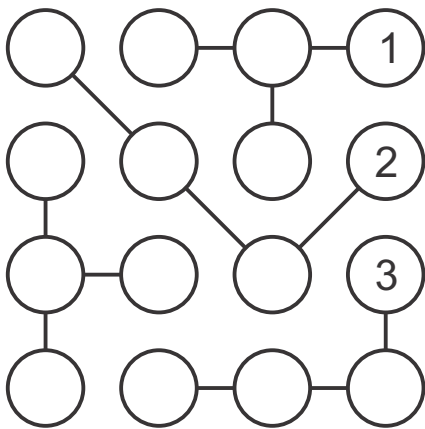

Puzzle 20

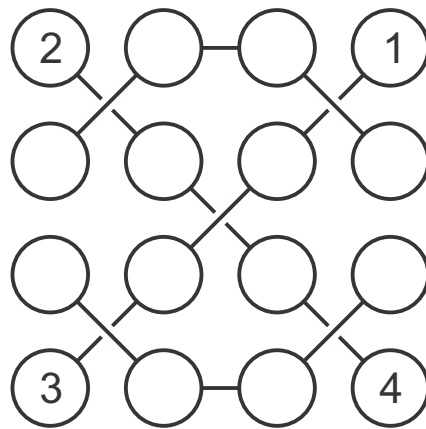

Puzzle 21

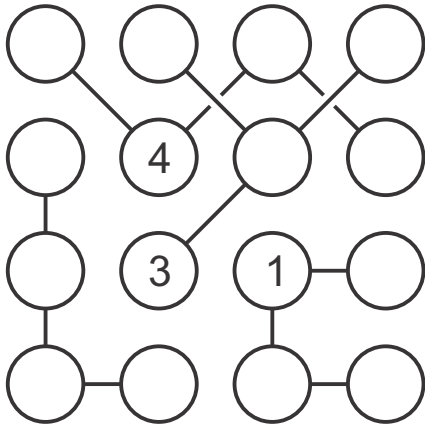

Puzzle 22

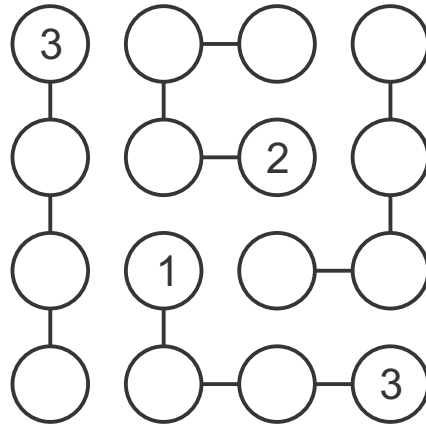

Puzzle 23

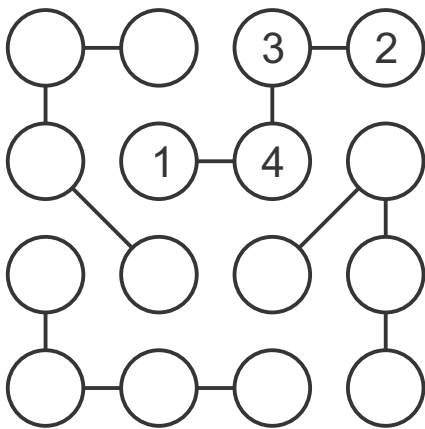

Puzzle 24

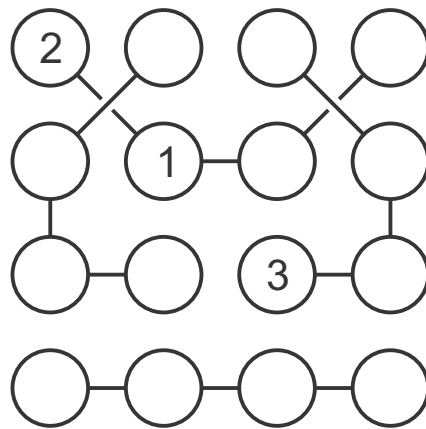

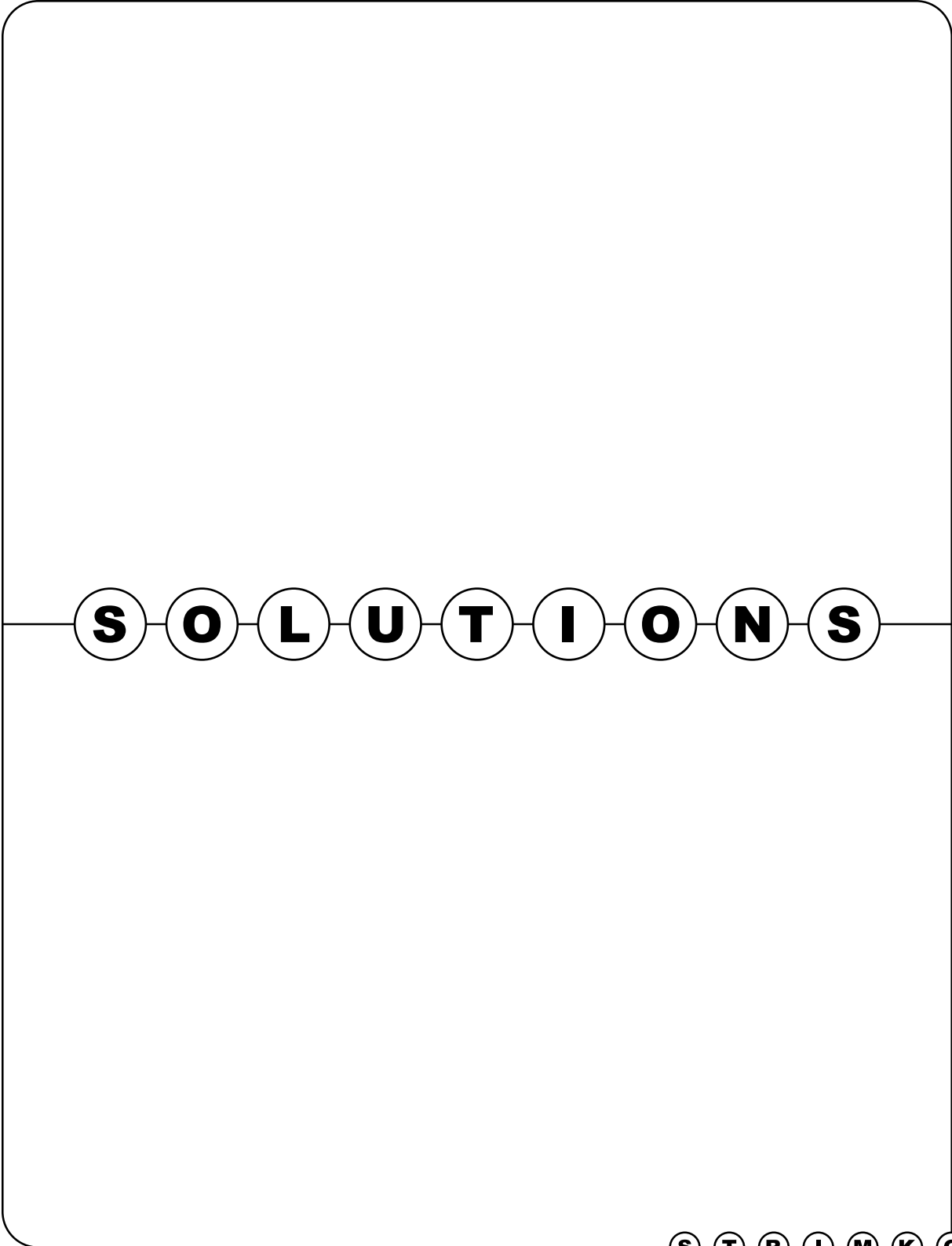

© 2009 The Grabarchuk Family. All Rights Reserved. [strimko.com](http://strimko.com)  
Permission is granted for personal use only. This puzzle may not be duplicated for any kind of profit

**S T R I M K O**<sup>TM</sup>

Solution 1

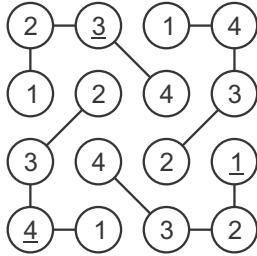

Solution 2

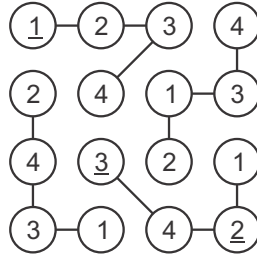

Solution 3

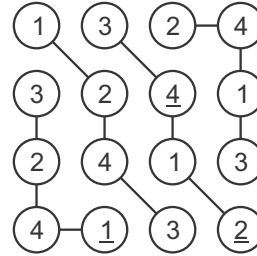

Solution 4

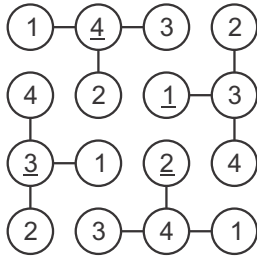

Solution 5

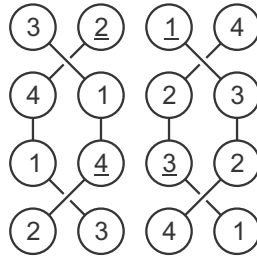

Solution 6

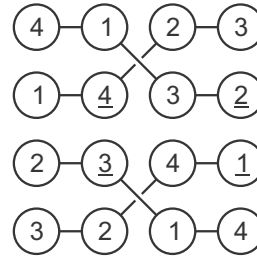

Solution 7

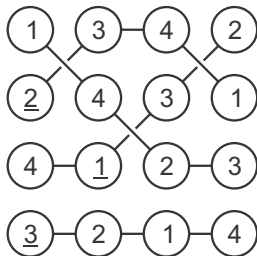

Solution 8

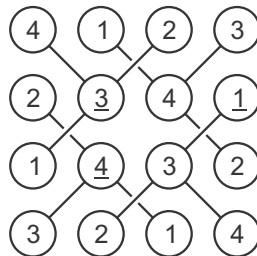

Solution 9

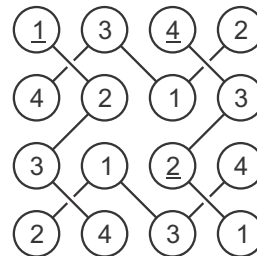

Solution 10

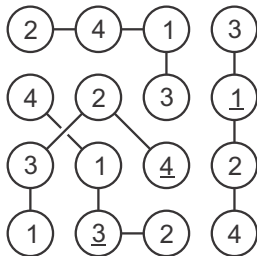

Solution 11

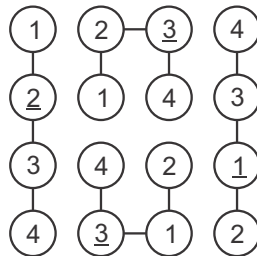

Solution 12

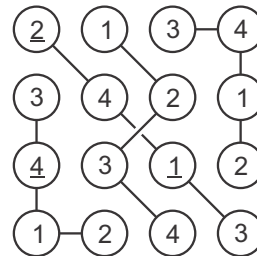

Solution 13

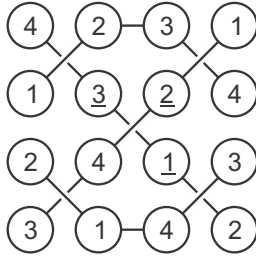

Solution 14

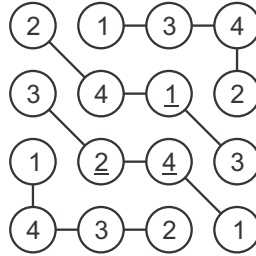

Solution 15

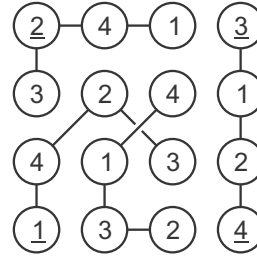

Solution 16

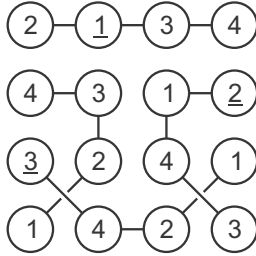

Solution 17

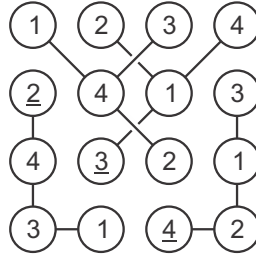

Solution 18

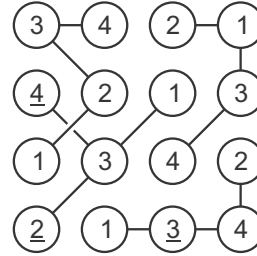

Solution 19

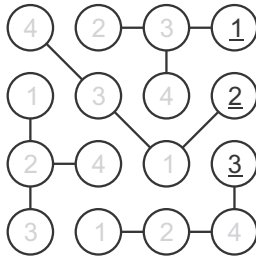

Solution 20

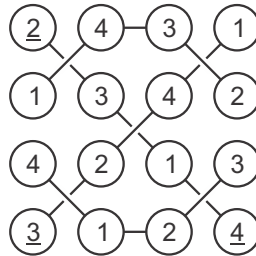

Solution 21

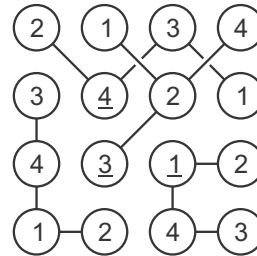

Solution 22

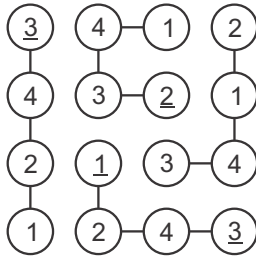

Solution 23

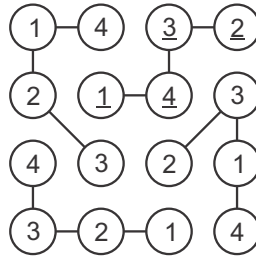

Solution 24

